

A vertical black lamp fixture is positioned against a rough stone wall, casting a warm, golden glow. To the left, a small wooden table with a lattice base holds a metal vase with dried flowers. To the right, a wicker chair with a brown cushion is partially visible. The scene is set in a rustic interior with stone walls and a stone floor.

**zafferano**  
LAMPES-À-PORTER

**Pencil**

# Pencil

Design Federico de Majo

Sospesa magicamente  
abbracciata o libera  
sembri sostenere il peso del tronco.  
Esile presenza  
ti presti a giocare  
in una luminosa danza.

Magically suspended  
embraced or free  
you appear to be bearing the weight of a trunk.  
Slender presence  
you play along  
in a luminous dance.

MODULO LUCE / CARICABATTERIE / BASE DI STAZIONAMENTO E RICARICA / BASE DI STAZIONAMENTO ROTANTE / SUPPORTI TAVOLO /  
SUPPORTI PARETE ORIZZONTALE / SUPPORTO PARETE VERTICALE / SUPPORTO SOSPENSIONE VERTICALE / SUPPORTI SOSPENSIONE  
ORIZZONTALE LIGHTING MODULE / BATTERY CHARGER / DOCKING AND CHARGING STATION / ROTATING DOCKING STATION / TABLE BASES  
/ HORIZONTAL WALL LAMP BRACKETS / VERTICAL WALL LAMP KIT / VERTICAL SUSPENSION KIT / HORIZONTAL SUSPENSION KIT



Pencil lighting module large white → **LD0802B3**  
Pencil lighting module medium white → **LD0801B3**  
Pencil lighting module small white → **LD0800B3**  
Cansiglio forest  
Treviso, Italy



Pencil è un modulo luminoso a batteria, portatile e ricaricabile, disponibile in tre misure, che grazie agli appositi accessori può diventare lampada da terra, tavolo, parete e a sospensione.

Dotato di sorgente luminosa a LED, Pencil produce una luce intensa e ben direzionata adatta a spazi pubblici e privati, anche outdoor (IP65).

La struttura, a sezione pentagonale, è in estrusione d'alluminio verniciato bianco, corten o grigio scuro; il diffusore è in policarbonato opale satinato.

Un dimmer touch a 4 steps permette di calibrare con precisione l'illuminazione di un ambiente, e di scegliere la temperatura di colore della luce tra 2700-3150-4000K.

Pencil può essere ricaricato in due modi: direttamente tramite caricatore (pagina 10); o a contatto sulla base di stazionamento, la quale può essere utilizzata anche solo come alloggio del modulo, per un utilizzo come lampada da terra o da tavolo (pagina 12).

Grazie alla scheda LED avanzata, un sistema di controllo elettronico monitora l'autonomia residua e garantisce un flusso luminoso costante fino all'esaurimento della batteria, permettendo di ottimizzare le ricariche ed effettuarle sempre in maniera corretta. La durata della batteria varia dalle 8h alle 58h, in base alla regolazione del flusso luminoso; i tempi di ricarica a 3,16A sono 6 ore per il modulo piccolo, 9 per il medio, 12 per il grande.

Pencil is a battery-operated portable and rechargeable lighting module, available in three sizes. Thanks to its dedicated accessories, it can become a floor, table, wall and suspension lamp. Equipped with a LED light source, Pencil creates an intense, well-directed light ideal for public and private spaces, also outdoors (IP65).

Its fixture, with a pentagonal cross-section, is made of white, corten or dark grey painted extruded aluminium. The diffuser is in satin opal polycarbonate.

Its 4-step dimmer touch control allows you to accurately adjust the lighting in a room and choose the light colour temperature, 2700-3150-4000K. Pencil can be recharged in two ways: either with the battery charger (page 10) or in the docking station, connected to a battery charger (page 12).

Thanks to a state-of-the-art LED circuit board, an electronic control system monitors the remaining autonomy and ensures a constant luminous flux until the battery runs out. Recharging is therefore optimised and always properly done. The battery lasts 8h - 58h, depending on the luminous flux setting. At 3.16A, recharging times are 6h for the small module, 9h for the medium module and 12h for the large module.

Pencil lighting module large white  
+ docking station white  
→ **LD0802B3 + LD0810B3**  
Osteria Stasera Corder - Treviso, Italy  
Photo phEsci Francesco Esci



Modulo luce  
Lighting module



pag. 6

Caricabatterie  
Battery charger



pag. 10

Base di stazionamento  
Docking station



pag. 12 - 14

Supporti tavolo  
Table bases

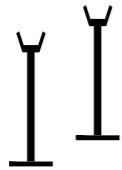

pag. 16

Supporti parete  
Wall brackets



pag. 18 - 20

Supporto a sospensione  
Suspension kit

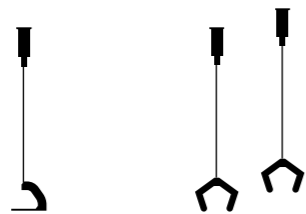

pag. 22 - 24

Batterie  
Batteries

pag. 26

Legenda e colophon  
Legend and colophon

pag. 28



→  
LD0800R3

# Pencil

## Modulo luce Lighting module



Video Pencil

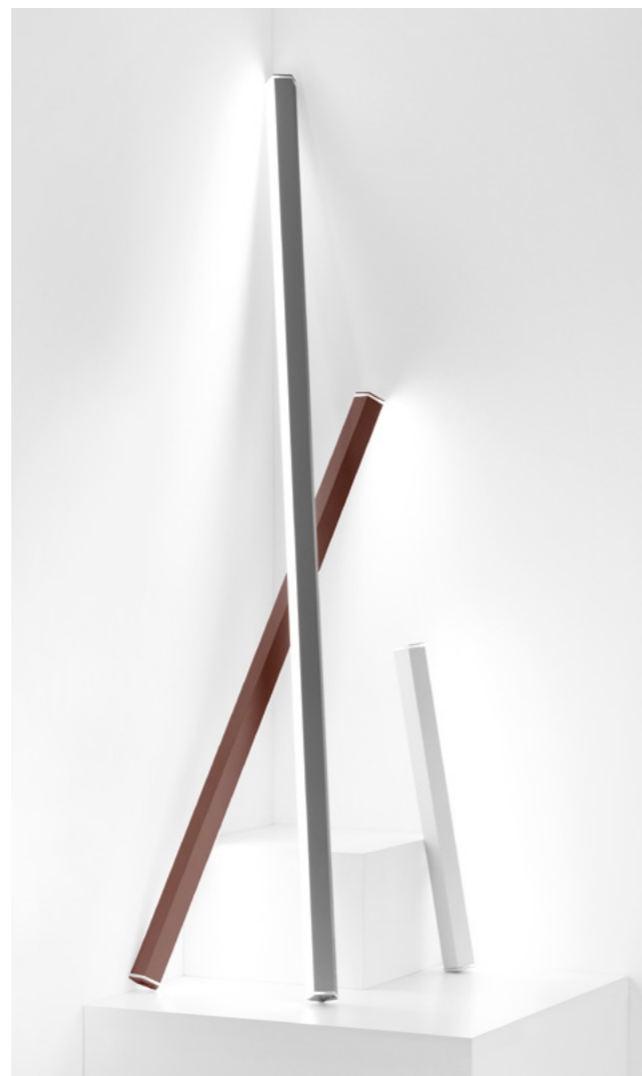

Pencil è un elemento luminoso a batteria portatile e ricaricabile, in tre misure, che grazie agli accessori dedicati può diventare lampada da terra, tavolo, parete e a sospensione. È dotato di: sistema di controllo elettronico che monitora l'autonomia residua e garantisce un flusso luminoso costante fino all'esaurimento della batteria, touch dimmer e della funzione di selezione della temperatura di colore della luce tra 2700-3150-4000K.

Pencil is a battery-operated portable and rechargeable lighting module, available in three sizes. Thanks to its dedicated accessories, it can become a floor, table, wall, and suspension lamp. It is equipped with: electronic control system that monitors the remaining autonomy and ensures constant luminous flux until the battery runs out, dimmer touch control and a light colour temperature selection function, 2700-3150-4000K.

Pencil lighting module medium white  
+ vertical suspension kit  
→ LD0801B3 + LD0811B3

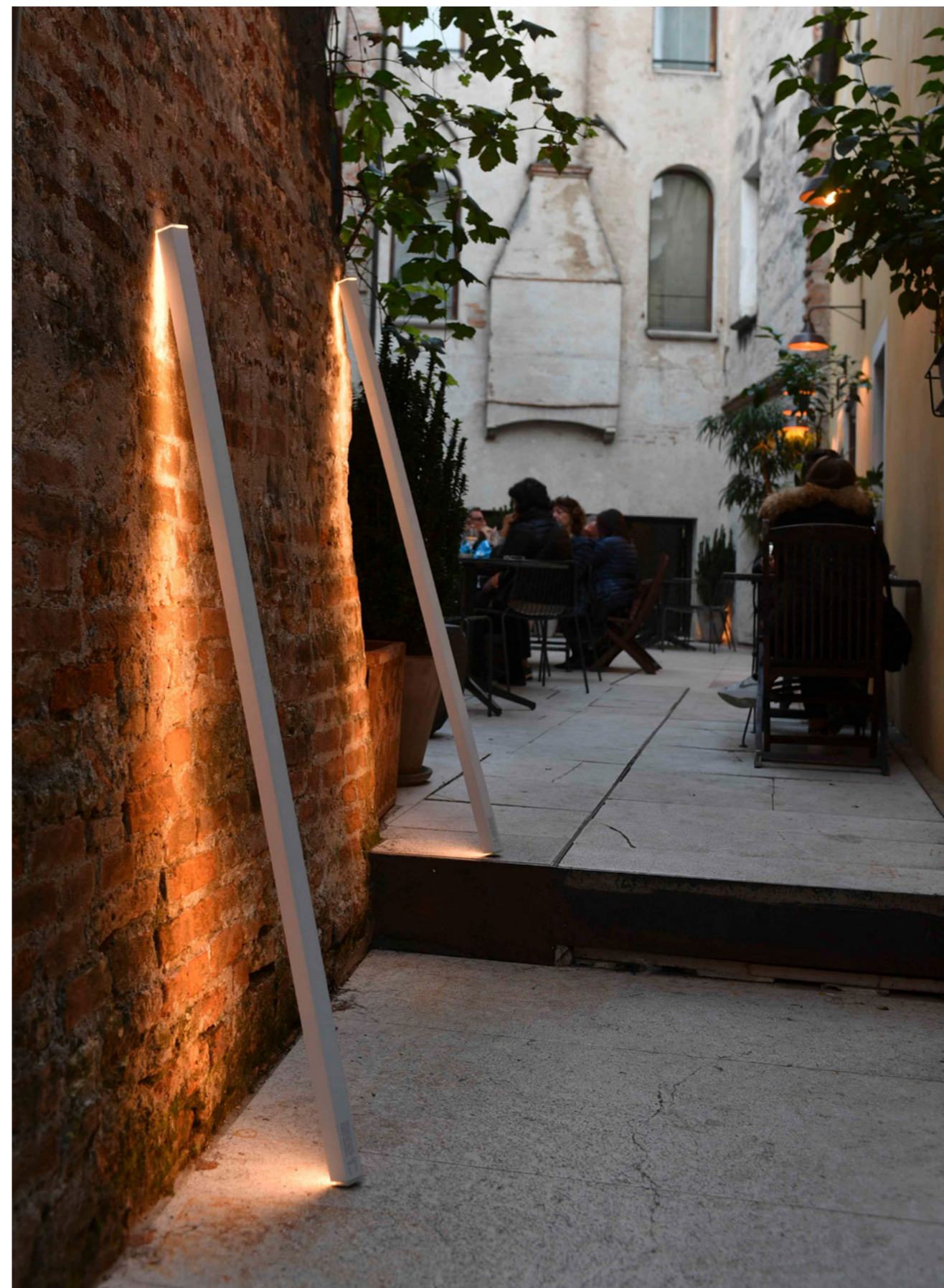

**Dati tecnici**

## Technical data

Small

LED DIMMER • 6W • 530-590-680lm  
2700-3150-4000K • IP65 • CRI>90  
100-240V • 50-60Hz • 19Vdc max 2,5A

Medium

LED DIMMER • 12W • 1050-1180-1350lm  
2700-3150-4000K • IP65 • CRI>90  
100-240V • 50-60Hz • 19Vdc max 2,5A

Large

LED DIMMER • 18W • 1340-1500-1700lm  
2700-3150-4000K • IP65 • CRI>90  
100-240V • 50-60Hz • 19Vdc max 2,5A

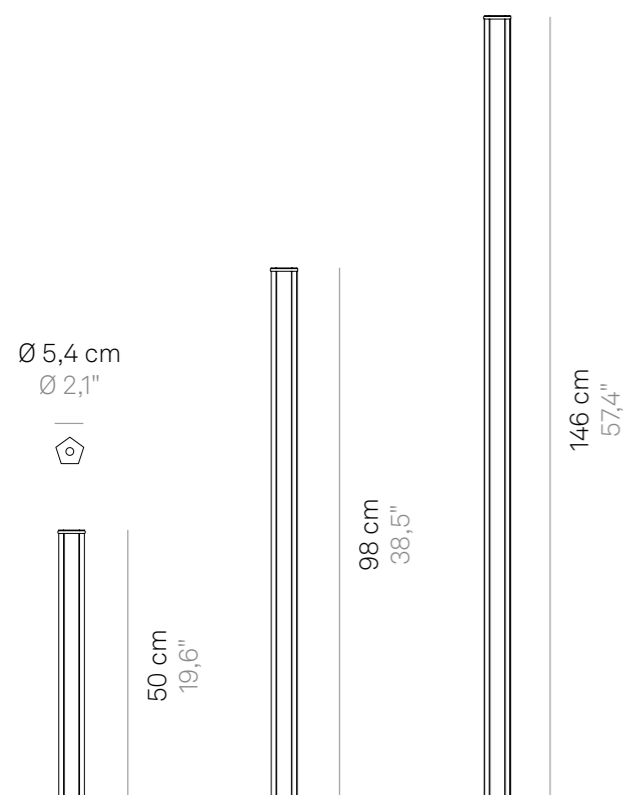

Pacchi batterie al litio ricaricabili e sostituibili  
Rechargeable and replaceable lithium battery packs

Durata 8 - 58 h, in base alla regolazione del flusso luminoso

Battery lasts 8 - 58 h, depending on the luminous flux setting.

Ricarica con connettore 3.5/1.3, oppure a contatto (quando usato su base ricarica)

Rechargeable with a 3.5/1.3 connector, or by contact (when used with the charging base)

Tempi di ricarica a 3,16A: 6/9/12 h (rispettivamente per misura piccola/media/grande)

Recharging times at 3.16A: 6/9/12 h (for small/medium/large size respectively)

Corpo in estrusione d'alluminio verniciato  
Painted extruded aluminium fixture

Diffusore in policarbonato opale satinato  
Satin opal polycarbonate diffuser

Adatta all'uso esterno (lampada IP65) e interno (lampada su base di ricarica IP20) → legenda pag. 28  
Suitable for outdoor (lamp IP65) and indoor use (lamp on charging base IP20) → legend pg. 28

Resistenza agli urti (IK07) e alla nebbia salina (1500h)  
Impact resistance (IK07) and salt spray resistance (1500h)

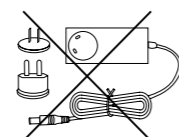

non incluso  
not included

**Non inclusi** → pag. 10  
**Not included** → pg. 10

Caricabatterie con connettore 3.5/1.3 \*  
Charger with a 3.5/1.3 connector \*

\* Componente necessario, da acquistare separatamente  
\* Necessary component, yet it must be purchased separately

**Attenzione**  
**Remarks**

Con gli accessori dedicati, il modulo luminoso Pencil può diventare lampada da terra, tavolo, parete e a sospensione.  
Thanks to its dedicated accessories, the lighting module can become a floor, table, wall and pendant lamp.

**Finiture**

## Finishes



Bianco  
White  
RAL 9003

Corten

Grigio scuro  
Dark grey  
RAL 7012

Small

**LD0800B3**

**LD0800R3**

**LD0800G3**

Medium

**LD0801B3**

**LD0801R3**

**LD0801G3**

Large

**LD0802B3**

**LD0802R3**

**LD0802G3**

**COMPONENTI NON INCLUSI**  
COMPONENTS NOT INCLUDED

Caricabatterie con connettore 3.5/1.3  
Charger with a 3.5/1.3 connector

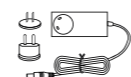

more info  
→ pag. 10

**DATI TECNICI / CODICE ARTICOLO / CODICE EAN / PREZZO \***  
TECHNICAL DATA / ITEM CODE / EAN CODE / PRICE\*

48W | 100-240V  
50-60Hz | 19Vdc max 2,5A  
**LD0800CS**  
8056300197973

**PARTI DI RICAMBIO (NON INCLUSE)**  
SPARE PARTS (NOT INCLUDED)

Pacchi batterie sostitutive per moduli luce  
Replacement battery packs for lighting modules



more info  
→ pag. 26

**DATI TECNICI / CODICE ARTICOLO / CODICE EAN / PREZZO \***  
TECHNICAL DATA / ITEM CODE / EAN CODE / PRICE\*

Small  
11,1V | 5000mA/H  
**BAT04702719700300**  
8054144502786

Medium  
11,1V | 10000mA/H  
**BAT04702739200600**  
8054144502793

Large  
11,1V | 15000mA/H  
**BAT04702758700900**  
8054144502809

# Pencil

## Caricabatterie Battery charger



LD0800CS

### Dati tecnici

#### Technical data

47,5W • 100-240V • 50-60Hz  
19Vdc max 2,5A

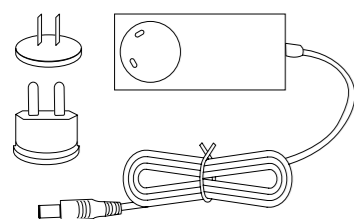

Il caricabatterie permette di ricaricare Pencil in due modi: collegando il cavo (fig. 1) direttamente al modulo luminoso; oppure collegando il cavo alla docking station in cui il modulo viene posizionato (fig. 2). È un componente necessario, ma da acquistare separatamente: la lunga durata della batteria di Pencil consente infatti di utilizzare un solo caricabatterie per caricare più moduli. Ha una forma compatta, un cavo con attacco 3,5/1,3 e una spina intercambiabile per EU/USA in dotazione; funziona a 100-240 Volts.

The battery charger allows the recharging of Pencil in two ways: either by connecting cable directly to the lighting module (fig. 1); or by connecting the cable to the docking station where the module is placed (fig. 2). It is a necessary component, yet it must be purchased separately: the long-lasting battery of Pencil enables to use just one battery charger to charge multiple lighting modules. It has a compact design, a cable with 3.5/1.3 connection and an interchangeable plug suitable for EU / USA standards; dual voltage 100/240V.



# Pencil

## Base di stazionamento e ricarica\*

Docking and charging station\*

\* Solo se connesso al caricatore

\* Only if connected with the charger



### Dati tecnici

Technical data

19Vdc max 3,16A

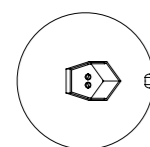
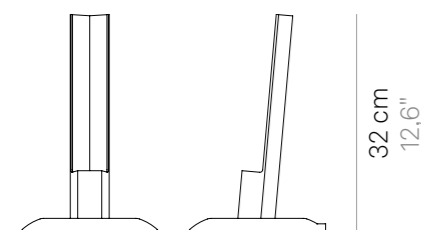

Ø 20 cm  
Ø 7,8"

### Finiture

Finishes



**LD0810B3**

Bianco  
White  
RAL 9003



**LD0810R3**

Corten



**LD0810G3**

Grigio scuro  
Dark grey  
RAL 7012

Corpo in alluminio verniciato  
Painted aluminium fixture

Adatta all'uso interno (IP20) → legenda pag. 28  
Suitable for indoor use (IP20) → legend pag. 28

Non inclusi → pag. 10  
Not included → pg. 10

Caricabatterie con connettore 3.5/1.3  
Charger with a 3.5/1.3 connector

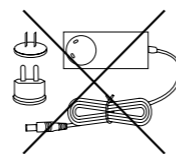

Accessorio con doppia funzione: è principalmente una base di stazionamento, che trasforma Pencil in lampada da terra o da tavolo; collegato al caricabatterie, diventa una base di ricarica a contatto per il modulo luminoso. Il modulo luminoso può essere usato nel suo alloggiamento fisso, ma anche rimosso e portato con sé da un ambiente all'altro.

A dual-function accessory: it is mainly used as a docking station, turning Pencil into a floor or table lamp. Connected to the battery charger, it becomes a contact charging base for the lighting module. The lighting module can be used in its fixed housing, or detached and carried from one place to another.

Pencil lighting module large white  
+ docking station white  
→ **LD0802B3 + LD0810B3**  
Osteria Stasera Corder - Treviso, Italy  
Photo phEsci Francesco Esci





# Pencil

## Base di stazionamento rotante\*

Rotating docking station\*

\* Non assolve la funzione di ricarica

\* Doesn't provide a charging function



### Dati tecnici

Technical data

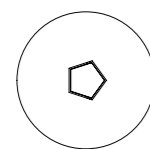
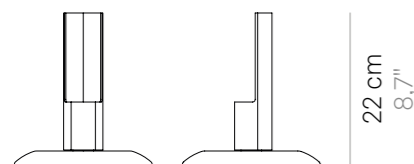

Ø 20 cm  
Ø 7,8"

### Finiture

Finishes



**LD0816B3**

Bianco  
White  
RAL 9003



**LD0816R3**

Corten



**LD0816G3**

Grigio scuro  
Dark grey  
RAL 7012

Corpo in alluminio verniciato  
Painted aluminium fixture

Base di stazionamento che trasforma Pencil (pag. 6) in lampada da terra o da tavolo. Questo accessorio mantiene il modulo luminoso in posizione perpendicolare rispetto al piano di appoggio, e ne permette la rotazione a 360° sull'asse longitudinale, in entrambi i sensi. A seconda dell'orientamento, il modulo produce luce diretta o indiretta. Il modulo luminoso può essere usato nel suo alloggiamento fisso, ma anche rimosso e portato con sé da un ambiente all'altro. Questa base di stazionamento non assolve la funzione di ricarica.

A docking station that turns Pencil (page 6) into a floor lamp or table lamp. This accessory keeps the lighting module in a perpendicular position in relation to the supporting surface, thereby allowing it to rotate 360° on the longitudinal axis, in both directions. Depending on the angle, the lighting module produces direct or indirect light. The lighting module can also be used in its fixed housing, or detached and carried from one place to another. This docking station does not provide a charging function.



# Pencil

## Supporti tavolo Table bases



### Dati tecnici Technical data

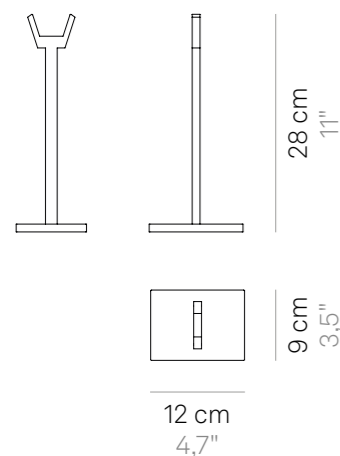

### Finiture Finishes



**LD081400**  
Trasparente  
Transparent

Supporti in PMMA trasparente  
Transparent PMMA structure

Elementi che trasformano Pencil in una lampada da tavolo. A seconda della posizione in cui è appoggiata sulle staffe, il modulo produce luce diretta o indiretta. Il modulo luminoso può essere usato nel suo alloggiamento fisso, ma anche rimosso e portato con sé da un ambiente all'altro.

Elements that turn Pencil into a table lamp. According to its position on the bases, it gives direct or indirect light. The lighting module can be used in its fixed housing, or detached and carried from one place to another.



Pencil lighting module small white  
+ horizontal wall lamp brackets white  
→ **LD0800B3 + LD081400**

# Pencil

## Supporti parete orizzontale Horizontal wall lamp brackets



### Dati tecnici Technical data

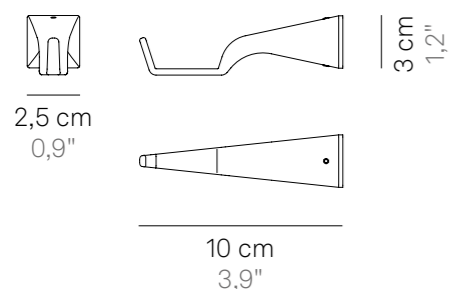

### Finiture Finishes



**LD0813B3**  
Bianco  
White  
RAL 9003



**LD0813R3**  
Corten



**LD0813G3**  
Grigio scuro  
Dark grey  
RAL 7014

Supporti in pressofusione d'alluminio verniciato  
Painted die-cast aluminium elements

I supporti da parete orizzontali trasformano Pencil in una lampada da parete orizzontale. A seconda della posizione in cui è appoggiato sui supporti, il modulo produce luce diretta o indiretta. Il modulo luminoso può essere usato nel suo alloggiamento fisso, ma anche rimosso e portato con sé da un ambiente all'altro.

The horizontal wall lamp brackets turn Pencil into a horizontal wall lamp. Depending on the position where it is placed on supporting fixtures, the lighting module produces direct or indirect light. The lighting module can also be used in its fixed housing, or detached and carried from one place to another.

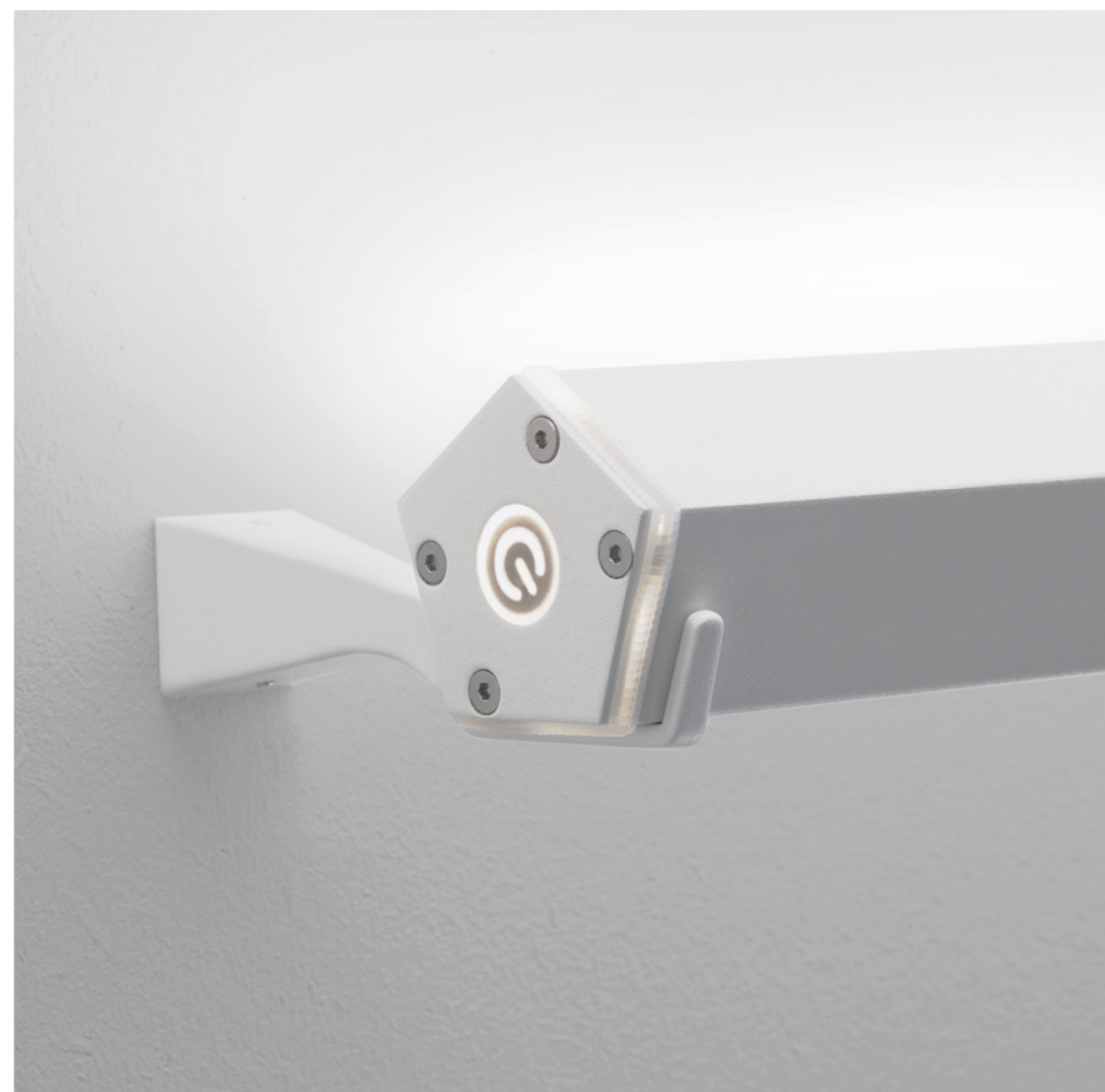

Pencil lighting module small white  
+ horizontal wall lamp brackets white  
→ **LD0800B3 + LD0815B3**

# Pencil

## Supporto parete verticale

Vertical wall lamp kit



### Dati tecnici

Technical data

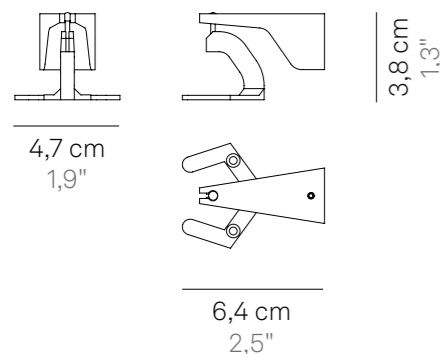

### Finiture

Finishes



**LD0815B3**  
Bianco  
White  
RAL 9003



**LD0815R3**  
Corten



**LD0815G3**  
Grigio scuro  
Dark grey  
RAL 7014

Supporto in pressofusione d'alluminio verniciato con particolari cromati  
Painted die-cast aluminium element with chromed details

Elemento che trasforma Pencil (pag.6) in una lampada da parete verticale, che ruota sul proprio asse longitudinale a 360°, in entrambi i sensi. A seconda dell'orientamento, il modulo produce luce diretta o indiretta.

Il modulo luminoso può essere usato nel suo alloggiamento fisso, ma anche rimosso e portato con sé da un ambiente all'altro.

Element that turns Pencil (page 6) into a vertical wall lamp, rotating on its longitudinal axis by 360°, in both directions: according to its position, the module gives direct or indirect light. The lighting module can be used in its fixed housing, or detached and carried from one place to another.



Pencil lighting module medium white  
+ vertical suspension kit white  
→ **LD0801B3** + **LD0811B3**

# Pencil

## Supporto sospensione verticale

Vertical suspension kit



### Dati tecnici

Technical data

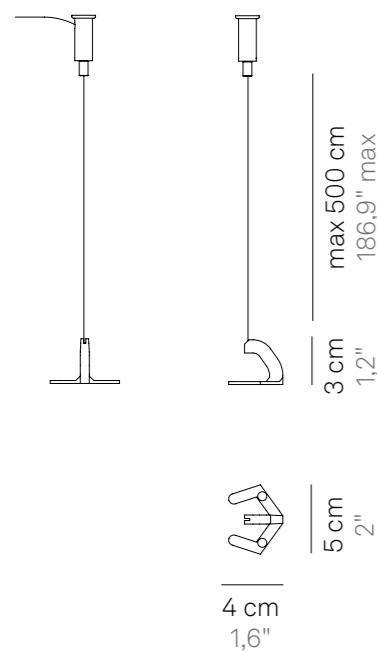

### Finiture

Finishes



**LD0811B3**  
Bianco  
White  
RAL 9003



**LD0811R3**  
Corten



**LD0811G3**  
Grigio scuro  
Dark grey  
RAL 7014

Supporto in pressofusione d'alluminio verniciato con particolari cromati  
Painted die-cast aluminium element with chromed details

**Accessori inclusi**  
Accessories included

Cavo in acciaio e staffe  
Steel cable and brackets

Elemento che trasforma Pencil in una lampada a sospensione verticale. Il modulo luminoso può essere usato nel suo alloggiamento fisso, ma anche rimosso e portato con sé da un ambiente all'altro.

Element that turns Pencil into a vertical suspension lamp. The lighting module can be used in its fixed housing, or detached and carried from one place to another.

Pencil lighting module medium white  
+ vertical suspension kit white  
→ **LD0801B3 + LD0811B3**



# Pencil

## Supporti sospensione orizzontale

Horizontal suspension kit



### Dati tecnici

Technical data

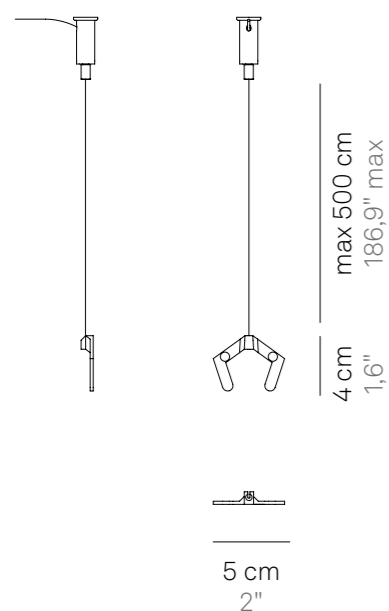

### Finiture

Finishes



**LD0812B3**  
Bianco  
White  
RAL 9003



**LD0812R3**  
Corten



**LD0812G3**  
Grigio scuro  
Dark grey  
RAL 7014

Supporto in pressofusione d'alluminio  
verniciato con particolari cromati  
Painted die-cast aluminium element with  
chromed details

**Accessori inclusi**  
Accessories included

Cavo in acciaio e staffe  
Steel cable and brackets

Elementi che trasformano Pencil in una lampada a sospensione orizzontale a luce diretta. Il modulo luminoso può essere usato nel suo alloggiamento fisso, ma anche rimosso e portato con sé da un ambiente all'altro.

Elements that turn Pencil into a horizontal suspension lamp. The lighting module can be used in its fixed housing, or detached and carried from one place to another.



Pencil lighting module medium dark grey  
+ horizontal suspension kit dark grey →  
**LD0801BG + LD0812G3**

## Batterie ricaricabili

### Rechargeable batteries

Le batterie ricaricabili con il loro utilizzo sono soggette ad usura. La vita delle batterie, il cui standard è di circa 450 ricariche, può essere ridotta da alcuni fattori come: ① la modalità non corretta di ricarica (la lampada va ricaricata quando è scarica: circa il 10% della sua autonomia residua); ② lunghi periodi di stazionamento senza utilizzo; ③ lunghi periodi di stazionamento su base di ricarica in tensione anche se la lampada risulta carica; ④ l'utilizzo di accessori non originali per la ricarica; ⑤ l'esposizione del prodotto a temperature molto alte o molto fredde.

Quando le lampade non si ricaricano più o l'autonomia dopo la ricarica risulta molto ridotta, le batterie devono essere sostituite. I ricambi delle lampade ricaricabili Zafferano sono disponibili a catalogo e identificati con apposito codice. La garanzia sulle batterie è valida solo per difetti di fabbricazione, che si possono verificare dopo il primo utilizzo.

All rechargeable batteries are subject to wear when used. The life of batteries, which can generally be recharged 450 times, may be reduced by certain factors: ① incorrect recharging mode (the lamp must be recharged when it is flat: about 10% of its remaining autonomy); ② when left unused for a long time; ③ when left for a long time on a live recharging base even if the lamp is recharged; ④ when non-original accessories are used for recharging; ⑤ when the product is exposed to very high or very low temperatures.

When the lamps no longer recharge or their autonomy after recharging is very short, the batteries must be replaced. Spare parts for Zafferano rechargeable lamps can be found in the catalogue and identified by a special code. The warranty for batteries is only valid for manufacturing defects, which may occur after initial use.

#### PACCO BATTERIA SOSTITUTIVA

##### REPLACEMENT BATTERY PACK

DATI TECNICI / CODICE ARTICOLO / CODICE EAN  
TECHNICAL DATA / ITEM CODE / EAN CODE

#### Small

Pacco batteria sostitutiva per modulo Pencil piccolo  
Replacement battery pack for small Pencil module

11,1V | 5000mA/H  
**BAT04702719700300**  
8054144502786



#### Medium

Pacco batteria sostitutiva per modulo Pencil medio  
Replacement battery pack for medium Pencil module

11,1V | 10000mA/H  
**BAT04702739200600**  
8054144502793







#### Large

Pacco batteria sostitutiva per modulo Pencil grande  
Replacement battery pack for large Pencil module

11,1V | 15000mA/H  
**BAT04702758700900**  
8054144502809



<p><b>CE</b></p> <p>CE Dichiara che il prodotto soddisfa gli standard dell'UE per la salute, la sicurezza e la protezione ambientale. Declares that the product meets EU standards for health, safety, and environmental protection.</p>	<p></p> <p>CLASS II Apparecchio dotato di doppio isolamento e/o isolamento rinforzato in ogni parte e senza dispositivo di messa a terra. Light fitting equipped with double isolation and/or isolation reinforced in every part and without earthing device.</p>	<p></p> <p>CLASS III Apparecchio basato su un'alimentazione a bassissima tensione di sicurezza, in cui non si producono tensioni superiori alla stessa. Light fitting based on a very low safety voltage power supply, in which no tensions higher than the same are produced.</p>	<p>IP</p> <p>IP PROTECTION DEGREE IP20: apparecchio protetto dalla penetrazione di corpi solidi di dimensioni maggiori a 12mm e non protetto dai liquidi. IP54: apparecchio protetto da polveri e da spruzzi d'acqua. IP65: apparecchio fortemente protetto da polveri e da getti d'acqua. IP20: protected from the penetration of solid objects greater than 12 mm and non protected from liquids. IP54: protected from dust and splashing water. IP65: highly protected from dust and water jets.</p>
<p></p> <p>DIMMABLE Indica che è possibile regolare l'intensità luminosa della lampada. Indicates that the light intensity of the lamp can be adjusted.</p>	<p></p> <p>INDOOR Identifica un prodotto con apparecchiature elettriche progettate principalmente per uso interno. Identifies a product with electrical equipment designed primarily for indoor use.</p>	<p></p> <p>OUTDOOR Identifica un prodotto con apparecchiature elettriche progettate sia per uso interno che esterno. Identifies a product with electrical equipment designed both for indoor and outdoor use.</p>	

Headquarters  
**Zafferano SRL**  
Viale dell'industria 26  
31055 Quinto di Treviso (TV), Italy  
T +39 0422 470507  
F +39 0422 470400  
vendite@zafferanoitalia.com

Subsidiary  
**Zafferano America LLC**  
301 Penhorn Avenue  
Suite 5,  
Secaucus, NJ 07094  
T +1 888 744 5277  
info@zafferanoamerica.com

Showrooms  
**Zafferano Store Milano**  
Via Fatebenefratelli, 23  
Milan (Italy)  
**Zafferano Store Treviso**  
Viale dell'Industria, 26  
Quinto di Treviso (Italy)

Art Direction, Graphic Design  
Zafferano Design

Photography  
Claudio Mainardi  
Alberto Sinigaglia  
Quasar

Poems  
Federico de Majo

Acknowledgements  
Porto Caleri, Rovigo  
Caglieron Caves, Treviso  
Storga river springs, Treviso  
Morgano countryside, Treviso  
Piave riverbed, Treviso  
Brent de l'Art, Belluno  
Rosolina pine forest, Rovigo  
Cansiglio forest, Treviso  
Euganean hills, Padua  
(Italy)

L'azienda si riserva di apportare modifiche e/o migliorie di carattere tecnico ed estetico ai propri modelli e prodotti in qualsiasi momento e senza preavviso.  
The company reserves the right to make modifications and improvements of a technical or aesthetic nature to the products at any time without notice.

Il prodotto è protetto da garanzia, a norma di legge.  
The product is covered by a warranty, according to the law.

© Copyright Zafferano SRL